

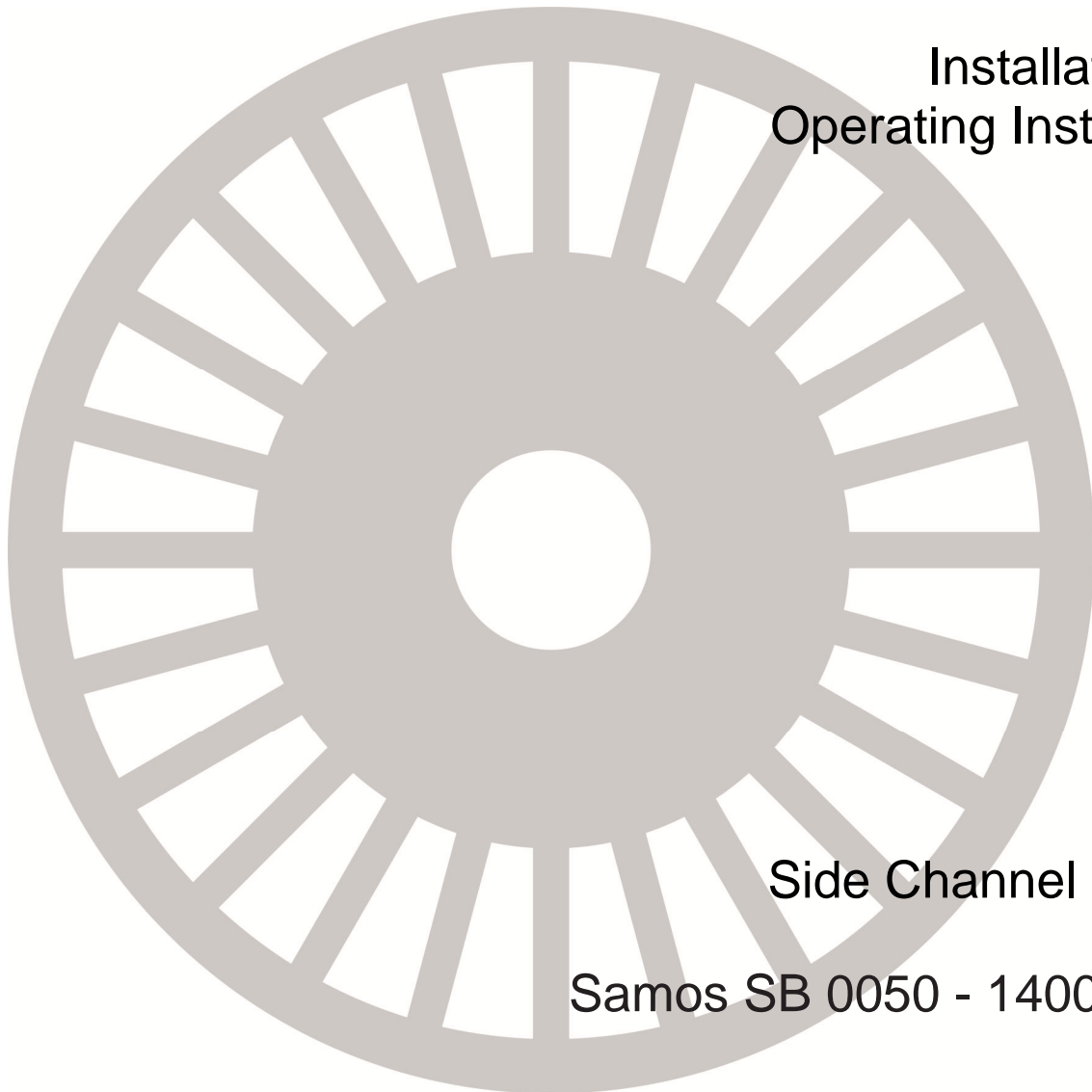

# Installation and Operating Instructions



Side Channel Blowers

Samos SB 0050 - 1400 D0/D2



Busch Produktions GmbH  
Schauinslandstr. 1  
79689 Maulburg  
Deutschland

# Table of Contents

Preface . . . . .	2
Technical Data . . . . .	2
Product Description . . . . .	3
Use . . . . .	3
Principle of Operation . . . . .	3
Cooling . . . . .	3
Start Controls . . . . .	3
Safety . . . . .	3
Intended Use . . . . .	3
Safety Notes . . . . .	3
Noise Emission . . . . .	4
Transport . . . . .	4
Transport in Packaging . . . . .	4
Transport without Packaging . . . . .	4
Storage . . . . .	4
Short-term Storage . . . . .	4
Conservation . . . . .	4
Installation and Commissioning . . . . .	5
Installation Prerequisites . . . . .	5
Mounting Position and Space . . . . .	5
Suction Connection/Gas Inlet . . . . .	5
Gas Discharge . . . . .	5
Pressure Connection . . . . .	6
Electrical Connection / Controls . . . . .	6
Controlling Pressure/Flow . . . . .	6
Installation . . . . .	6
Mounting . . . . .	6
Connecting Electrically . . . . .	6
Connection Scheme Alternating Current Motor . . . . .	6
Connection Scheme Three-Phase Motor . . . . .	7
Connecting Lines/Pipes . . . . .	7
Recording of Operational Parameters . . . . .	7
Operation Notes . . . . .	7
Use . . . . .	7
Maintenance . . . . .	8
Maintenance Schedule . . . . .	8
Monthly: . . . . .	8
Every 6 Months: . . . . .	8
Every Year: . . . . .	8
Overhaul . . . . .	8
Removal from Service . . . . .	9
Temporary Removal from Service . . . . .	9
Recommissioning . . . . .	9
Dismantling and Disposal . . . . .	9
Spare Parts . . . . .	9
Troubleshooting . . . . .	10
Exploded Views . . . . .	13
EC-Declaration of Conformity . . . . .	19
Busch – All over the World in Industry . . . . .	20

# Preface

Congratulations on your purchase of the Busch side channel blower. With watchful observation of the field's requirements, innovation and steady development Busch delivers modern vacuum and pressure solutions worldwide.

These operating instructions contain information for

- product description,
- safety,
- transport,
- storage,
- installation and commissioning,
- maintenance,
- overhaul,
- troubleshooting and
- spare parts

of the side channel blower.

For the purpose of these instructions, "handling" the side channel blower means the transport, storage, installation, commissioning, influence on operating conditions, maintenance, troubleshooting and overhaul of the side channel blower.

**Prior to handling the side channel blower these operating instructions shall be read and understood. If anything remains to be clarified please contact your Busch representative!**

**Keep these operating instructions and, if applicable, other pertinent operating instructions available on site.**

# Technical Data

Motor connection parameters, nominal speeds and allowed differential pressures are given on the nameplate of the side channel blower. More technical data, available sizes, versions and accessories are given in the current sales programme. In case of further questions please contact your Busch representative!

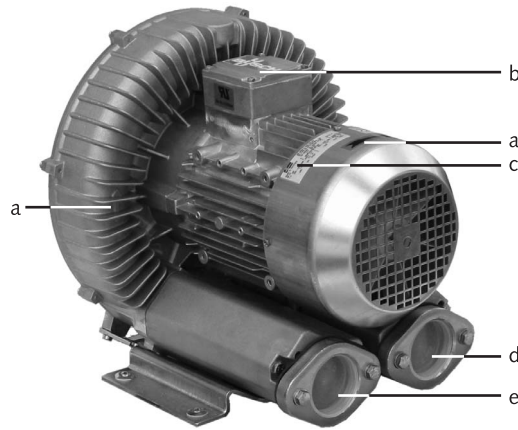

- a Directional arrows
- b Terminal box
- c Nameplate
- d Gas discharge/ pressure connection
- e Suction connection/ gas inlet

## Product Description

### Use

The side channel blower is intended for

- the suction
- the compression

of

- air and other dry, non-aggressive, non-toxic and non-explosive gases

Conveying media with a lower or higher density than air leads to an increased thermal and/or mechanical load on the side channel blower and is permissible only after prior consultation with Busch.

The gas shall be free from vapours that would condensate under the temperature and pressure conditions inside the side channel blower.

The side channel blower is intended for the placement in a non-potentially explosive environment.

The side channel blower is suitable for continuous operation, provided that the housing can transmit heat to the environment without obstruction and a certain minimum gas transfer is warranted. If there is a risk that the side channel blower may be operated against a closed inlet or outlet for more than a few seconds, a vacuum or pressure relief valve, respectively, shall be provided. Frequent switching on and off leads to increased coil temperatures. In case of doubt seek advice from your Busch representative!

The nominal value (=reference value for performance data) for the temperature of the process gas is 15 °C. The max. allowed temperature of the inlet gas is 40 °C.

The nominal value for the ambient temperature is 25 °C. The min. allowed ambient temperature is -30 °C. The max. allowed ambient temperature is 40 °C.

Binding data with regard to the allowed differential pressure are to be read from the nameplate (value with negative sign ("-") for vacuum operation, value without sign for pressure operation). The data is valid for ambient temperatures up to 25 °C and location altitudes up to 1000 m above sea level. Higher ambient temperatures reduce the allowed differential pressures by up to 10 percent at 40 °C. In case of placement in altitudes beyond 1000 m above sea level the allowed differential pressure shall be agreed upon with Busch.

**The maximum allowed pressure on the pressure connection (d) is 2 bar abs. By means of process control and/or pressure relief valves it must be made sure that the maximum allowed pressure will not be exceeded.**

### Principle of Operation

The side channel blower works on the impulse principle, i.e. kinetic energy is transferred from the rotor to the conveyed medium and then is converted into pressure.

For the two stage version:

2 stages, both working on the principle described above, are installed in line in order to achieve a better ultimate/differential pressure.

The side channel blower compresses the inlet gas absolutely oil-free. A lubrication of the pump chamber is neither necessary nor allowed.

### Cooling

The side channel blower is cooled by

- radiation of heat from the surface of the side channel blower
- the air flow from the fan wheel of the drive motor
- the process gas

### Start Controls

The side channel blower comes without start controls. The control of the side channel blower is to be provided in the course of installation.

## Safety

### Intended Use

**Definition:** For the purpose of these instructions, "handling" the side channel blower means the transport, storage, installation, commissioning, influence on operating conditions, maintenance, troubleshooting and overhaul of the side channel blower.

The side channel blower is intended for industrial use. It shall be handled only by qualified personnel.

**The allowed media and operational limits (→ page 3: Product Description) and the installation prerequisites (→ page 5: Installation Prerequisites) of the side channel blower shall be observed both by the manufacturer of the machinery into which the side channel blower is to be incorporated and by the operator.**

The maintenance instructions shall be observed.

**Prior to handling the side channel blower these installation and operating instructions shall be read and understood. If anything remains to be clarified please contact your Busch representative!**

### Safety Notes

The side channel blower has been designed and manufactured according to state-of-the-art methods. Nevertheless, residual risks may remain. These operating instructions highlight potential hazards where appropriate. Safety notes are tagged with one of the keywords DANGER, WARNING and CAUTION as follows:



**DANGER**

**Disregard of this safety note will always lead to accidents with fatal or serious injuries.**



## WARNING

Disregard of this safety note may lead to accidents with fatal or serious injuries.



## CAUTION

Disregard of this safety note may lead to accidents with minor injuries or property damage.

## Noise Emission



## CAUTION

Depending on the construction size the side channel blower can emit noise of high intensity.

Depending on the operating state the side channel blower can emit noise in a narrow band.

Risk of damage to the hearing.

Persons staying in the vicinity of a non noise insulated side channel blower over extended periods shall wear ear protection.

## Transport

### Transport in Packaging

Side channel blowers individually packed in cardboard boxes can be carried by hand.

Packed on a pallet the side channel blower is to be transported with a forklift.

### Transport without Packaging

In case the side channel blower is packed in a cardboard box with inflated cushions:

- ◆ Remove the inflated cushions from the box

In case the side channel blower is in a cardboard box cushioned with rolled corrugated cardboard:

- ◆ Remove the corrugated cardboard from the box

In case the side channel blower is laid in foam:

- ◆ Remove the foam

In case the side channel blower is bolted to a pallet or a base plate:

- ◆ Remove the bolting between the side channel blower and the pallet/base plate

In case the side channel blower is fastened to the pallet by means of tightening straps:

- ◆ Remove the tightening straps

In case the side channel blower weighs less than 20 kg and comes without eyebolts for the attachment of lifting gear:

Version without handle:

- ◆ Grasp the side channel blower with both hands

Version with handle:

- ◆ Carry the side channel blower using the handle

In case the side channel blower comes with one or more eyebolts for the attachment of lifting gear:



## CAUTION

Do not walk, stand or work under suspended loads.

- Make sure that the eyebolt is in faultless condition (replace a damaged, e.g. bent eyebolt with a new one)

- Make sure that the eyebolt is fully screwed in and tightened by hand
- Attach lifting gear securely to the eyebolt on the cylinder
- Attach the lifting gear to a crane hook with safety latch
- Lift the side channel blower with a crane

In case the side channel blower was bolted to a pallet or a base plate:

- ◆ Remove the stud bolts from the rubber feet

## Storage

### Short-term Storage

- Make sure that the suction connection/gas inlet and the gas discharge/pressure connection are closed (leave the provided plugs in)
- Store the side channel blower
  - if possible in original packaging,
  - indoors,
  - dry,
  - dust free and
  - vibration free

### Conservation

In case of adverse ambient conditions (e.g. aggressive atmosphere, frequent temperature changes) conserve the side channel blower immediately. In case of favourable ambient conditions conserve the side channel blower if a storage of more than 3 months is scheduled.

- Make sure that all ports are firmly closed; seal all ports that are not sealed with PTFE-tape, gaskets or o-rings with adhesive tape

**Note:** VCI stands for "volatile corrosion inhibitor". VCI-products (film, paper, cardboard, foam) evaporate a substance that condenses in molecular thickness on the packed good and by its electro-chemical properties effectively suppresses corrosion on metallic surfaces. However, VCI-products may attack the surfaces of plastics and elastomers. Seek advice from your local packaging dealer! Busch uses CORTEC VCI 126 R film for the overseas packaging of large equipment.

- Wrap the side channel blower in VCI film
- Store the side channel blower
  - if possible in original packing,
  - indoors,
  - dry,
  - dust free and
  - vibration free.

For commissioning after conservation:

- Make sure that all remains of adhesive tape are removed from the ports
- Commission the side channel blower as described in the chapter Installation and Commissioning (→ page 5)

# Installation and Commissioning

## Installation Prerequisites



### CAUTION

In case of non-compliance with the installation prerequisites, particularly in case of insufficient cooling:

Risk of damage or destruction of the side channel blower and adjoining plant components!

Risk of injury!

The installation prerequisites must be complied with.

- Make sure that the integration of the side channel blower is carried out such that the essential safety requirements of the Machine Directive 2006/42/EC are complied with (in the responsibility of the designer of the machinery into which the side channel blower is to be incorporated; → page 19: note in the EC-Declaration of Conformity)

## Mounting Position and Space

- Make sure that the environment of the side channel blower is not potentially explosive
- Make sure that the following ambient conditions will be complied with:
  - ambient temperature:  $-30 \dots +40 \text{ }^\circ\text{C}$
  - ambient pressure: atmospheric
- Make sure that the environmental conditions comply with the protection class of the drive motor (according to the nameplate)

The side channel blower can be operated with horizontal or vertical gas flow

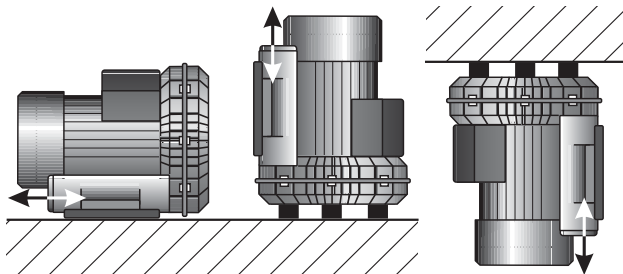

- Make sure that the mounting base is even
- Make sure that in order to warrant a sufficient cooling there will be a clearance of minimum 0.1 m between the side channel blower and nearby walls
- Make sure that there will be a clearance of minimum 3.5 cm (up to construction size 140) or 5.5 cm (as of constructions size 200) between the fan hood and nearby walls/ceiling
- Make sure that there will be a clearance of minimum 2 cm (up to construction size 200), 3 cm (for construction size 310) or 4 cm (as of constructions size 530), respectively, between the cover (2.030) and nearby walls/floor

In case of mounting with the drive motor in the uppermost position:

- ◆ Provide vibration insulating rubber feet to fasten the side channel blower to the floor
- Make sure that no heat sensitive parts (plastics, wood, cardboard, paper, electronics) will touch the surface of the side channel blower
- Make sure that the installation space or location is vented such that a sufficient cooling of the side channel blower is warranted



### CAUTION

During operation the surface of the side channel blower may reach temperatures of more than  $70 \text{ }^\circ\text{C}$ .

Risk of burns!

- Make sure that the side channel blower will not be touched inadvertently during operation, provide a guard if appropriate

## Suction Connection/Gas Inlet



### CAUTION

Intruding foreign objects or liquids can destroy the side channel blower.

In case the inlet gas can contain dust or other foreign solid particles:

- ◆ Make sure that a suitable filter (5 micron or less) is installed upstream the side channel blower

In case of compressor operation:

The following guidelines for the suction line do not apply, if the air to be compressed is taken in right at the side channel blower.

- Make sure that the suction line fits to the suction connection/gas inlet (e) of the side channel blower
- Make sure that the gas will be sucked through a vacuum-tight flexible hose or a pipe

In case of using a pipe:

- ◆ Make sure that the pipe will cause no stress on the side channel blower's connection, if necessary use an expansion joint
- Make sure that the line size of the suction line over the entire length is at least as large as the suction connection/gas inlet (e) of the side channel blower

In case the length of the suction line exceeds 2 m it is prudent to use larger line sizes in order to avoid a loss of efficiency and an overload of the side channel blower. Seek advice from your Busch representative!

In case the vacuum shall be maintained after shutdown of the side channel blower:

- ◆ Provide a manual or automatic operated valve (= non-return valve) in the suction line
- Make sure that the suction line does not contain foreign objects, e.g. welding scales

In case the side channel blower will be used for vacuum application and is likely to run against a closed inlet for more than a few seconds:

- ◆ Provide a vacuum relief valve and set it to approx. 75 percent of the max. differential pressure

In case of doubt seek advice from your Busch representative!

## Gas Discharge

In case of vacuum operation:

**The discharged gas must flow without obstruction. It is not permitted to shut off or throttle the discharge line or to use it as a pressurised air source.**

In case of vacuum operation:

The following guidelines for the discharge line do not apply, if the aspirated air is discharged to the environment right at the side channel blower.

- Make sure that the discharge line fits to the gas discharge (d) of the side channel blower

In case of using a pipe:

- ◆ Make sure that the pipe will cause no stress on the side channel blower's connection, if necessary use an expansion joint

- Make sure that the line size of the discharge line over the entire length is at least as large as the gas discharge (d) of the side channel blower

In case the length of the discharge line exceeds 2 m it is prudent to use larger line sizes in order to avoid a loss of efficiency and an overload of the side channel blower. Seek advice from your Busch representative!

- Make sure that the discharge line either slopes away from the side channel blower or provide a liquid separator or a drip leg with a drain cock, so that no liquids can back up into the side channel blower

## Pressure Connection

- Make sure that the pressure line fits to the pressure connection (d) of the side channel blower
- Make sure that the pressure connection is connected to a pressure-tight flexible hose or a pipe

In case of using a pipe:

- ◆ Make sure that the pipe will cause no stress on the side channel blower's connection, if necessary use an expansion joint
- Make sure that the line size of the pressure line over the entire length is at least as large as the pressure connection (d) of the side channel blower

In case the length of the pressure line exceeds 2 m it is prudent to use larger line sizes in order to avoid a loss of efficiency and an overload of the side channel blower. Seek advice from your Busch representative!

- Make sure that the pressure line either slopes away from the side channel blower or provide a liquid separator or a drip leg with a drain cock, so that no liquids can back up into the side channel blower

In case the side channel blower will be used for pressure application and is likely to run against a closed outlet for more than a few seconds:

- ◆ Provide a pressure relief valve and set it to approx. 75 percent of the max. differential pressure

In case of doubt seek advice from your Busch representative!

## Electrical Connection / Controls

- Make sure that the stipulations acc. to the EMC-Directive 2004/108/EC and Low-Voltage-Directive 2006/95/EC as well as the EN-standards, electrical and occupational safety directives and the local or national regulations, respectively, are complied with (this is the responsibility of the designer of the machinery into which the side channel blower is to be incorporated; → page 19: note in the EC-Declaration of Conformity).
- Make sure that the power supply for the drive motor is compatible with the data on the nameplate of the drive motor
- Make sure that an overload protection according to EN 60204-1 is provided for the drive motor
- Make sure that the drive of the side channel blower will not be affected by electric or electromagnetic disturbance from the mains; if necessary seek advice from the Busch service

In case of mobile installation:

- ◆ Provide the electrical connection with grommets that serve as strain-relief

## Controlling Pressure/Flow

Vacuum operation:

- In order to relieve excess vacuum or to limit the air flow use vent valves. Do not control the vacuum or the flow by throttling of suction or discharge lines. Conveying bypass air will let the side channel blower run cooler and draw less power.

Pressure operation:

- In order to relieve excess pressure or to limit the air flow use bleed valves. Do not control the pressure or the flow by throttling of suction or pressure lines. Bleeding excess air will let the side channel blower run cooler and draw less power.

## Installation

### Mounting

- Make sure that the Installation Prerequisites (→ page 5) are complied with
- Fasten the side channel blower at its location

### Connecting Electrically



WARNING

Risk of electrical shock, risk of damage to equipment.

Electrical installation work must only be executed by qualified personnel that knows and observes the following regulations:

- IEC 364 or CENELEC HD 384 or DIN VDE 0100, respectively,
- IEC-Report 664 or DIN VDE 0110,
- BGV A2 (VGB 4) or corresponding national accident prevention regulation.



CAUTION

The connection schemes given below are typical. Depending on the specific order or for certain markets deviating connection schemes may apply.

Risk of damage to the drive motor!

The inside of the terminal box shall be checked for drive motor connection instructions/schemes.

- Electrically connect the drive motor
- Connect the protective earth conductor

### Connection Scheme Alternating Current Motor

Low voltage connection (version **without** motor protection):

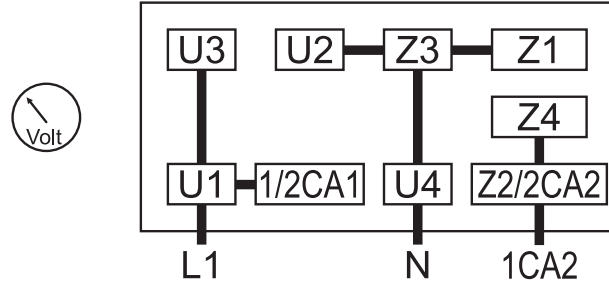

High voltage connection (version **without** motor protection):

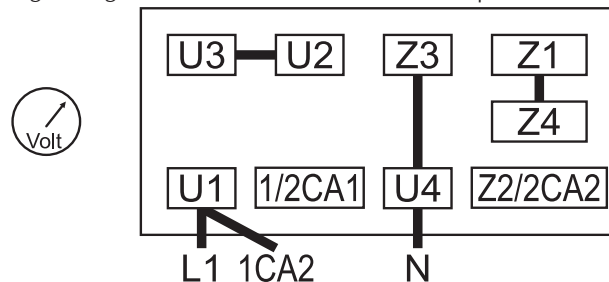

Low voltage connection (version **with** motor protection):

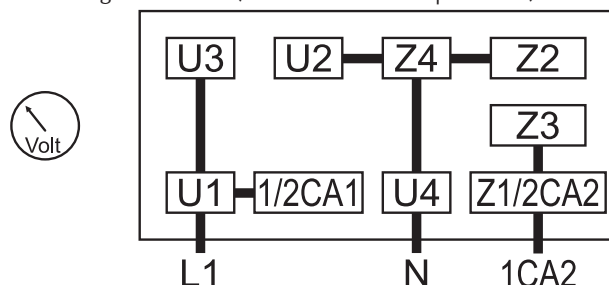

High voltage connection (version **with** motor protection):

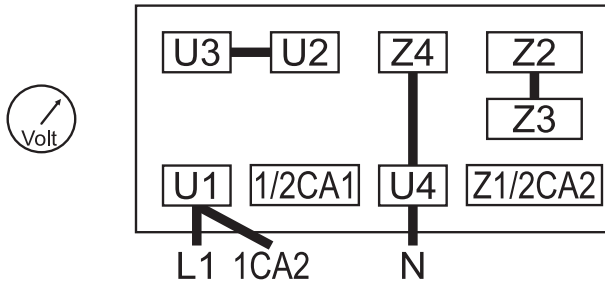

Connection motor protection:

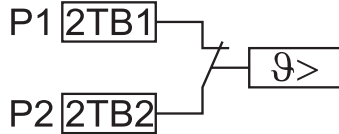

### Connection Scheme Three-Phase Motor

Delta connection (low voltage):

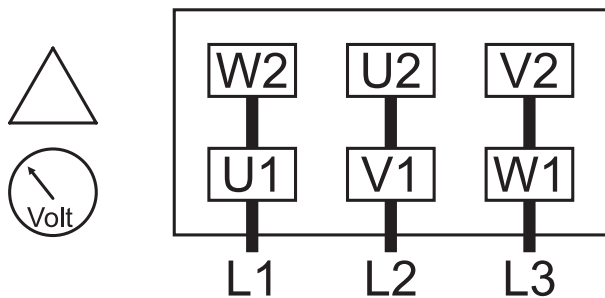

Star connection (high voltage):

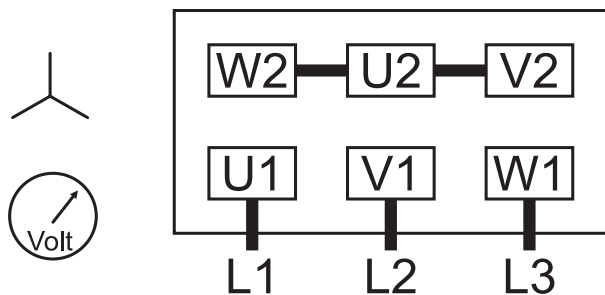

#### CAUTION

Operation in the wrong direction of rotation can destroy the side channel blower in short time.

Prior to starting-up it must be made sure that the side channel blower is operated in the proper direction.

**Note:** If certain applications require reverse operation over short periods, please seek advice from your Busch representative!

Version with three-phase motor:

- ◆ Determine the intended direction of rotation with the arrow (stuck on or cast)
- ◆ "Bump" the drive motor
- ◆ Watch the fan wheel of the drive motor and determine the direction of rotation just before the fan wheel stops

If the rotation must be changed:

- ◆ Switch any two of the drive motor wires (three-phase motor)

### Connecting Lines/Pipes

- Connect the suction line

Installation without suction line:

- ◆ Make sure that the gas inlet (e) is open

- Connect the discharge line

or

- Connect the pressure line

Installation without discharge line:

- ◆ Make sure that the gas discharge (d) is open
- Make sure that all provided covers, guards, hoods etc. are mounted
- Make sure that cooling air inlets and outlets are not covered or obstructed and that the cooling air flow is not affected adversely in any other way

In case the side channel blower comes with an eyebolt for the attachment of lifting gear:

- ◆ Make sure that the eyebolt is firmly tightened

### Recording of Operational Parameters

As soon as the side channel blower is operated under normal operating conditions:

- Measure the drive motor current and record it as reference for future maintenance and troubleshooting work

### Operation Notes

#### Use



#### CAUTION

The side channel blower is designed for operation under the conditions described below.

In case of disregard risk of damage or destruction of the side channel blower and adjoining plant components!

Risk of injury!

The side channel blower must only be operated under the conditions described below.

The side channel blower is intended for

- the suction
  - the compression
- of
- air and other dry, non-aggressive, non-toxic and non-explosive gases

Conveying media with a lower or higher density than air leads to an increased thermal and/or mechanical load on the side channel blower and is permissible only after prior consultation with Busch.

The gas shall be free from vapours that would condensate under the temperature and pressure conditions inside the side channel blower.

The side channel blower is intended for the placement in a non-potentially explosive environment.

The side channel blower is suitable for continuous operation, provided that the housing can transmit heat to the environment without obstruction and a certain minimum gas transfer is warranted. If there is a risk that the side channel blower may be operated against a closed inlet or outlet for more than a few seconds, a vacuum or pressure relief valve, respectively, shall be provided. Frequent switching on and off leads to increased coil temperatures. In case of doubt seek advice from your Busch representative!

The nominal value (=reference value for performance data) for the temperature of the process gas is 15 °C. The max. allowed temperature of the inlet gas is 40 °C.

The nominal value for the ambient temperature is 25 °C. The min. allowed ambient temperature is -30 °C. The max. allowed ambient temperature is 40 °C.

Binding data with regard to the allowed differential pressure are to be read from the nameplate (value with negative sign ("-") for vacuum

operation, value without sign for pressure operation). The data is valid for ambient temperatures up to 25 °C and location altitudes up to 1000 m above sea level. Higher ambient temperatures reduce the allowed differential pressures by up to 10 percent at 40 °C. In case of placement in altitudes beyond 1000 m above sea level the allowed differential pressure shall be agreed upon with Busch.

**The maximum allowed pressure on the pressure connection (d) is 2 bar abs. By means of process control and/or pressure relief valves it must be made sure that the maximum allowed pressure will not be exceeded.**

 CAUTION

During operation the surface of the side channel blower may reach temperatures of more than 70 °C.

Risk of burns!

The side channel blower shall be protected against contact during operation, it shall cool down prior to a required contact or heat protection gloves shall be worn.

 CAUTION

Depending on the construction size the side channel blower may emit noise of high intensity.

Depending on the operating state the side channel blower may emit noise in a narrow band.

Risk of damage to the hearing.

Persons staying in the vicinity of a non noise insulated side channel blower over extended periods shall wear ear protection.

- Make sure that all provided covers, guards, hoods etc. remain mounted
- Make sure that protective devices will not be disabled
- Make sure that cooling air inlets and outlets will not be covered or obstructed and that the cooling air flow will not be affected adversely in any other way
- Make sure that the installation prerequisites (→ page 5: Installation Prerequisites) are complied with and will remain complied with, particularly that a sufficient cooling will be ensured

## Maintenance

 DANGER

**In case the side channel blower conveyed gas that was contaminated with foreign materials which are dangerous to health, harmful material can reside in filters.**

Danger to health during inspection, cleaning or replacement of filters.

Danger to the environment.

Personal protective equipment must be worn during the handling of contaminated filters.

Contaminated filters are special waste and must be disposed of separately in compliance with applicable regulations.

 CAUTION

During operation the surface of the side channel blower may reach temperatures of more than 70 °C.

Risk of burns!

- Prior to disconnecting connections make sure that the connected pipes/lines are vented to atmospheric pressure

## Maintenance Schedule

**Note:** The maintenance intervals depend very much on the individual operating conditions. The intervals given below shall be considered as starting values which should be shortened or extended as appropriate. Particularly heavy duty operation, such like high dust loads in the environment or in the process gas, other contaminations or ingress of process material, can make it necessary to shorten the maintenance intervals significantly.

### Monthly:

- Make sure that the side channel blower is shut down and locked against inadvertent start up

In case an inlet air filter is installed:

- ◆ Check the inlet air filter, if necessary replace

In case of operation in a dusty environment:

- ◆ Clean as described under → page 8: Every 6 Months:

### Every 6 Months:

- Make sure that the housing is free from dust and dirt, clean if necessary
- Make sure that the side channel blower is shut down and locked against inadvertent start up
- Clean the fan cowling, the fan wheel, the ventilation grille and the cooling fins

### Every Year:

- Make sure that the side channel blower is shut down and locked against inadvertent start up

In case an inlet air filter is installed:

- ◆ Replace the inlet air filter

In case an inlet screen is installed:

- ◆ Check the inlet screen, clean if necessary

## Overhaul

 CAUTION

In order to achieve best efficiency and a long life the side channel blower was assembled and adjusted with precisely defined tolerances.

This adjustment will be lost during dismantling of the side channel blower.

It is therefore strictly recommended that any dismantling of the side channel blower that is beyond of what is described in this manual shall be done by Busch service.

 DANGER

**In case the side channel blower conveyed gas that was contaminated with foreign materials which are dangerous to health, harmful material can reside in pores, gaps and internal spaces of the side channel blower.**

Danger to health during dismantling of the side channel blower.

Danger to the environment.

Prior to shipping the side channel blower shall be decontaminated as good as possible and the contamination status shall be stated in a "Declaration of Contamination" (form downloadable from [www.busch-vacuum.com](http://www.busch-vacuum.com)).

Busch service will only accept side channel blowers that come with a completely filled in and legally binding signed "Declaration of Contamination" (form downloadable from [www.busch-vacuum.com](http://www.busch-vacuum.com)).

## Removal from Service

### Temporary Removal from Service

- Prior to disconnecting pipes/lines make sure that all pipes/lines are vented to atmospheric pressure

### Recommissioning

- Observe the chapter Installation and Commissioning (→ page 5)

### Dismantling and Disposal



**DANGER**

In case the side channel blower conveyed gas that was contaminated with foreign materials which are dangerous to health, harmful material can reside in pores, gaps and internal spaces of the side channel blower.

Danger to health during dismantling of the side channel blower.

Danger to the environment.

During dismantling of the side channel blower personal protective equipment must be worn.

**The side channel blower must be decontaminated prior to disposal.**

- Make sure that materials and components to be treated as special waste have been separated from the side channel blower
- Make sure that the side channel blower is not contaminated with harmful foreign material

According to the best knowledge at the time of printing of this manual the materials used for the manufacture of the side channel blower involve no risk.

- Dispose of the side channel blower as scrap metal

## Spare Parts

The bearings (1.007, 6.008) are intended as spare parts. Commercially available standard parts are to be purchased on the open market. If an overhaul requires parts other than bearings or standard parts your Busch representative will clarify whether an overhaul is economic or a replacement side channel blower should be considered.

**Note:** When ordering spare parts or accessories always quote the type and the serial no. of the side channel blower (data on the nameplate).

# Troubleshooting



## WARNING

Risk of electrical shock, risk of damage to equipment.

Electrical installation work must only be executed by qualified personnel that knows and observes the following regulations:

- IEC 364 or CENELEC HD 384 or DIN VDE 0100, respectively,
- IEC-Report 664 or DIN VDE 0110,
- BGV A2 (VBG 4) or equivalent national accident prevention regulation.



## CAUTION

During operation the surface of the side channel blower may reach temperatures of more than 70 °C.

Risk of burns!

Let the side channel blower cool down prior to a required contact or wear heat protection gloves.

Problem	Possible Cause	Remedy
<p>The side channel blower does not reach the usual pressure</p> <p>The drive motor draws a too high current (compare with initial value after commissioning)</p> <p>Vacuum operation:</p> <p>Evacuation of the system takes too long</p> <p>Pressure operation:</p> <p>Filling the system takes too long</p> <p>Building up pressure in the system takes too long</p>	<p>Vacuum operation:</p> <p>The vacuum system or suction line is not leak-tight</p> <p>Pressure operation:</p> <p>The pressure system or pressure line is not leak-tight</p>	Check the hose or pipe connections for possible leak
	<p>In case a vacuum relief valve/regulating system is installed:</p> <p>The vacuum relief valve/regulating system is misadjusted or defective</p> <p>In case a pressure relief valve/regulating system is installed:</p> <p>The pressure relief valve/regulating system is misadjusted or defective</p>	Adjust, repair or replace, respectively
	<p>In case a screen is installed in the suction connection/gas inlet (e):</p> <p>The screen in the suction connection/gas inlet (e) is partially clogged</p>	<p>Clean the screen</p> <p>If cleaning is required too frequently install a filter upstream</p>
	<p>In case a filter is installed on the suction connection/gas inlet (e):</p> <p>The filter on the suction connection/gas inlet (e) is partially clogged</p>	Clean or replace the inlet air filter, respectively
	<p>Partial clogging in the suction, discharge or pressure line</p>	Remove the clogging
	<p>Long suction, discharge or pressure line with too small diameter</p>	Use larger diameter
	<p>Internal parts are worn or damaged</p>	Repair the side channel blower (Busch service)
	<p>The gas conveyed by the side channel blower smells displeasing</p>	<p>Process components evaporating under vacuum</p>
<p>The side channel blower does not start</p>	<p>The drive motor is not supplied with the correct voltage or is overloaded</p>	Supply the drive motor with the correct voltage

	The drive motor starter overload protection is too small or trip level is too low	Compare the trip level of the drive motor starter overload protection with the data on the nameplate, correct if necessary In case of high ambient temperature: set the trip level of the drive motor starter overload protection 5 percent above the nominal drive motor current
	One of the fuses has blown	Check the fuses
	Version with alternating current motor: The drive motor capacitor is defective	Repair the drive (Busch service)
	The connection cable is too small or too long causing a voltage drop at the side channel blower	Use sufficiently dimensioned cable
	The side channel blower or the drive motor is blocked	Make sure the drive motor is disconnected from the power supply Remove the fan cover Try to turn the drive motor with the side channel blower by hand If the side channel blower is blocked: Repair the side channel blower (Busch service)
	The drive motor is defective	Replace the drive motor (Busch service)
The side channel blower is blocked	Solid foreign matter has entered the side channel blower	Repair the side channel blower (Busch service) Make sure the suction line is equipped with a screen If necessary additionally provide a filter
	Corrosion in the side channel blower from remaining condensate	Repair the side channel blower (Busch service) Check the process
	Version with three-phase motor: The side channel blower was run in the wrong direction	Repair the side channel blower (Busch service) When connecting the side channel blower make sure the side channel blower will run in the correct direction (→ page 6: Installation)
The side channel blower starts, but labours or runs noisily or rattles The drive motor draws a too high current (compare with initial value after commissioning)	Loose connection(s) in the drive motor terminal box Version with three-phase-motor: Not all drive motor coils are properly connected The drive motor operates on two phases only	Check the proper connection of the wires against the connection diagram Tighten or replace loose connections
	Version with three-phase motor: The side channel blower runs in the wrong direction	Verification and rectification → page 5: Installation and Commissioning
	Foreign objects in the side channel blower Stuck bearings	Repair the side channel blower (Busch service)
	Defective bearings	Repair the side channel blower (Busch service)
The side channel blower runs very hot	Insufficient air ventilation	Make sure that the cooling of the side channel blower is not impeded by dust/dirt Clean the fan cowling, the fan wheel, the ventilation grille and the cooling fins Install the side channel blower in a narrow space only if sufficient ventilation is ensured
	Ambient temperature too high	Observe the permitted ambient temperatures
	Temperature of the inlet gas too high	Observe the permitted temperatures for the inlet gas

Insufficient gas transfer	Vacuum operation: Provide a vacuum relief valve Pressure operation: Provide a pressure relief valve
Mains frequency or voltage outside tolerance range	Provide a more stable power supply
In case a vacuum relief valve/regulating system is installed:  The vacuum relief valve/regulating system is misadjusted or defective  In case a pressure relief valve/regulating system is installed:  The pressure relief valve/regulating system is misadjusted or defective	Adjust, repair or replace, respectively
Partial clogging of filters or screens Partial clogging in the suction, discharge or pressure line	Remove the clogging
Long suction, discharge or pressure line with too small diameter	Use larger diameter





# SB 0530 - 0710 D0

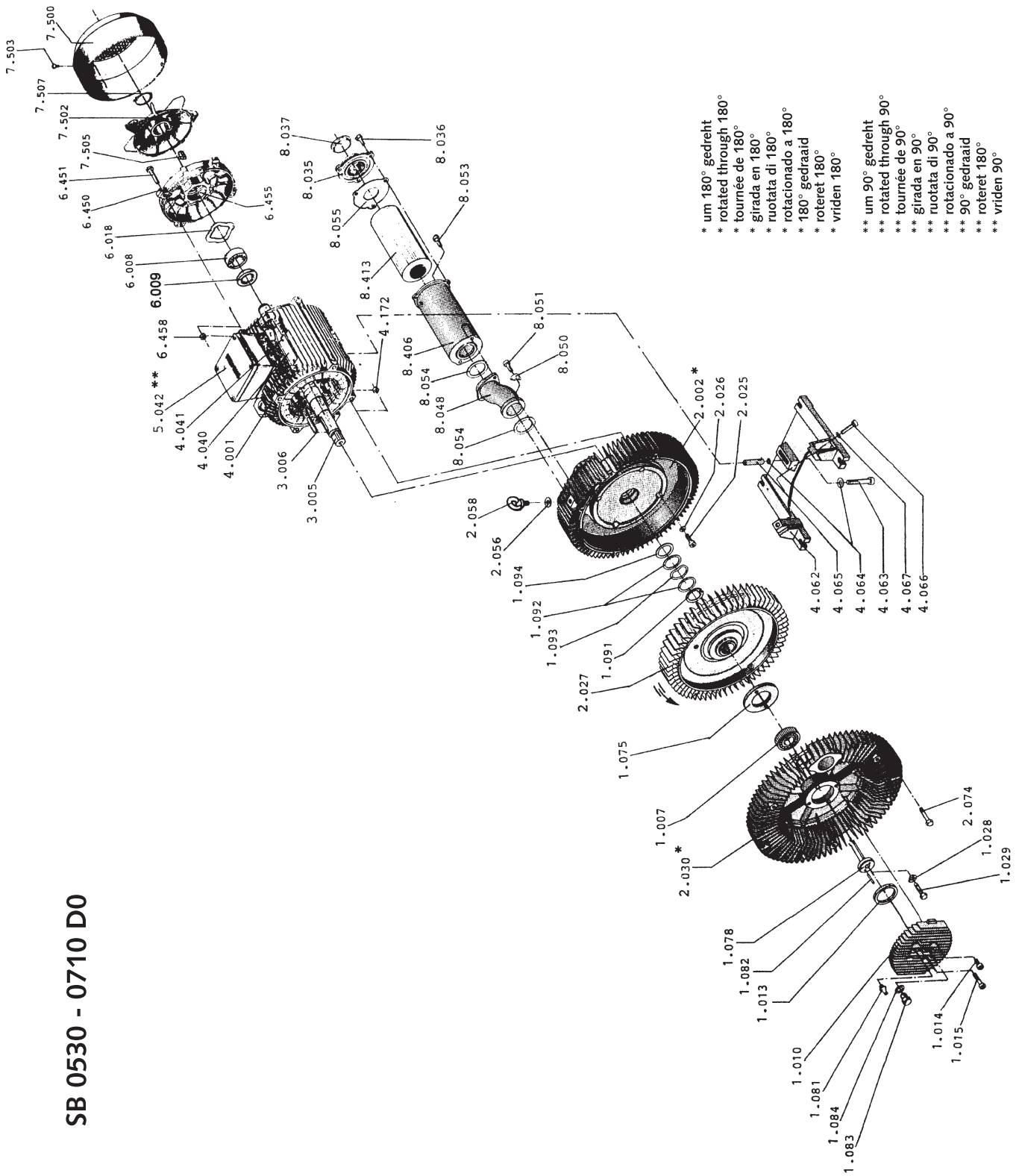







# EC-Declaration of Conformity

**Note:** This Declaration of Conformity and the CE-mark affixed to the nameplate are valid for the machine within the Busch scope of delivery. This Declaration of Conformity is issued under the sole responsibility of the manufacturer.  
When this machine is integrated into a superordinate machinery the manufacturer of the superordinate machinery (this can be the operating company, too) must conduct the conformity assessment process for the superordinate machine or plant, issue the Declaration of Conformity for it and affix the CE-mark.

We

**Busch Produktions GmbH**  
**Schauinslandstr. 1**  
**79689 Maulburg**  
**Germany**

Declare that the vacuum pumps **SB 0050 - 1400 D0/D2**

with a serial number from **D1601...** to **D1752...**

has (have) been manufactured in accordance with the European Directives:

- 'Machinery' 2006/42/EC
- 'Electromagnetic Compatibility' 2014/30/EU
- 'RoHS' 2011/65/EU, restriction of the use of certain hazardous substances in electrical and electronic equipment

and following the standards.

Standard	Title of the Standard
EN ISO 12100: 2010	Safety of machinery –General principles for design –Risk assessment and risk reduction
EN ISO 13857: 2008	Safety of machinery - Safety distances to prevent hazard zones being reached by the upper and lower limbs
EN 1012-1: 2010 EN 1012-2: 1996 + A1: 2009	Compressors and vacuum pumps - Safety requirements - Part 1 and Part 2
EN ISO 2151: 2008	Acoustics - Noise test code for compressors and vacuum pumps - Engineering method (grade 2)
EN 60204-1: 2006	Safety of machinery - Electrical equipment of machines - Part 1: General requirements
EN 61000-6-2: 2005	Electromagnetic compatibility (EMC) - Generic immunity standards. Immunity for industrial environments
EN 61000-6-4: 2007 + A1: 2011	Electromagnetic compatibility (EMC) - Generic immunity standards. Emission standard for industrial environments
EN ISO 13849-1:2015 <sup>(1)</sup>	Safety of machinery - Safety-related parts of control systems - Part 1: General principles for design

<p>Manufacturer</p>  <p><b>Dr.-Ing. Karl Busch</b> General Director</p>	<p>Person authorized to compile the technical file</p> <p><b>Andrej Riwe</b> Technical writer</p>
--	---

Maulburg, 04.04.2016

## Australia

Busch Australia Pty. Ltd.  
30 Lakeside Drive  
Broadmeadows, Vic. 3047  
Tel: (03) 93 55 06 00  
Fax: (03) 93 55 06 99

## Austria

Busch Austria GmbH  
Industriepark Nord  
2100 Korneuburg  
Tel: 02262 / 756 65-0  
Fax: 02262 / 756 65-20

## Belgium

Busch N.V./Busch SA  
Kruinstraat 7  
9160 Lokeren  
Tel: (0)9 / 348 47 22  
Fax: (0)9 / 348 65 35

## Brazil

Busch do Brasil Ltda.  
Rod. Edgard Máximo Zambotto, Km 64  
13240-000 Jarinu-SP  
Tel: (55) 11-4016 1400/5277  
Fax: (55) 11-4016 5399

## Canada

Busch Vacuum Technics Inc.  
1740, Boulevard Lionel Bertrand  
Boisbriand (Montréal)  
Québec J7H 1N7  
Tel: 450 435 6899  
Fax: 450 430 5132

## Chile

Busch Chile S. A.  
Calle El Roble N° 375-G  
Lampa - Santiago  
Tel: (56-2) 7387092  
Fax: (56-2) 7387092

## China

Busch Vacuum (Shanghai) Co., Ltd  
No.5, Lane 195 Xipu Road  
Songjiang Industrial Estate East New Zone  
Shanghai 201611 PRC  
Tel: +86 (0)21 67600800  
Fax: +86 (0)21 67600700

## Czech Republic

Busch Vakuum s.r.o.  
Pražákova 10  
619 00 Horní Heršpice  
Brno  
Tel: +420 543 42 48 55  
Fax: +420 543 42 48 56

## Denmark

Busch Vakuumtechnik A/S  
Parallevej 11  
8680 Ry  
Tel: +45 87 88 07 77  
Fax: +45 87 88 07 88

## Finland

Busch Vakuumtechnik Oy  
Sinikellontie 4  
01300 VANTAA  
Tel: 09 774 60 60  
Fax: 09 774 60 666

## France

Busch France S.A.  
Parc Technologique  
de Bois Chaland CE 2922  
91029 Evry Cedex  
Tel: 01 69 89 89 89  
Fax: 01 60 86 16 74

## Germany

Dr.-Ing. K. Busch GmbH  
Schauinslandstr. 1  
79689 Maulburg  
Tel: (0 76 22) 6 81-0  
Fax: (0 76 22) 6 81-194  
e-mail: info@busch.de

Dr.-Ing. K. Busch GmbH  
Niederlassung Nord  
Ernst-Abbe-Str. 1-3  
25451 Quickborn  
Tel: (0 41 06) 7 99 67-0  
Fax: (0 41 06) 7 99 67-77

Dr.-Ing. K. Busch GmbH  
Niederlassung West  
Nordring 35  
64807 Dieburg  
Tel: (0 60 71) 92 82-0  
Fax: (0 60 71) 14 71

Dr.-Ing. K. Busch GmbH  
Außenstelle Neuenrade  
Breslauer Str. 36  
58809 Neuenrade  
Tel: (0 23 92) 50 29 92  
Fax: (0 23 92) 50 72 11

Dr.-Ing. K. Busch GmbH  
Niederlassung Süd-Ost  
Gewerbestraße 3  
90579 Langenzenn  
Tel: (09 01) 90 25-0  
Fax: (09 01) 90 25-25

Dr.-Ing. K. Busch GmbH  
Außenstelle Zella-Mehlis  
Am Rain 11  
98544 Zella-Mehlis  
Tel: (0 36 82) 46 92 71  
Fax: (0 36 82) 46 92 73

Dr.-Ing. K. Busch GmbH  
Außenstelle Meitingen-Ostendorf  
Grünteweg 8  
86405 Meitingen-Ostendorf  
Tel: (0 82 71) 426-341  
Fax: (0 82 71) 426-342

## India

Busch Vacuum India Pvt Ltd.  
Plot No. 110, Sector 7  
PCNTDA, Bhosari  
Pune 411026, Maharashtra  
Tel: (0)206410 2886  
Fax: (0)202711 2838

## Ireland

Busch Ireland Ltd.  
A10-11 Howth Junction Business Centre  
Kilbarrack, Dublin 5  
Tel: 00353 1 832 1466  
Fax: 00353 1 832 1470

## Israel

Busch Israel Ltd.  
1 Mevo Sivan Street  
Qiryat Gat 82022, Israel  
Tel: +972 (0)8 6810485  
Fax: +972 (0)8 6810486

## Italy

Busch Italia S.r.l.  
Via Ettore Majorana, 16  
20054 Nova Milanese  
Tel: 0362 370 91  
Fax: 0362 370 999

## Japan

Nippon Busch K.K.  
1-23-33, Megumigaoka  
Hiratsuka City, Kanagawa  
Japan 259-1220  
Tel: 0463-50-4000  
Fax: 0463-50-4004

## Korea

Busch Korea Ltd.  
392-1 Yangji-Ri, Yangji-Myun,  
Yongin-si, Kyunggi-Do  
Tel: (031) 321-8114  
Fax: (031) 321 4330

## Malaysia

Busch (Malaysia) Sdn Bhd.  
6 Jalan Taboh 33/22  
Shah Alam Technology Park  
Section 33  
40400 Shah Alam  
Selangor D. E.  
Tel: 03 5122 2128  
Fax 03 5122 2108

## Mexico

Busch Vacuum Mexico S de RL de CV  
Tlaquepaque 4865, Los Altos  
Monterrey, Nuevo Leon  
Mexico 64370  
Tel: (81) 8311-1385  
Fax: (81) 8311-1386

## Netherlands

Busch B.V.  
Pompomolenlaan 2  
3447 GK Woerden  
Postbus 2091  
3440 DB Woerden  
Tel: (0)348 - 462300  
Fax: (0)348 - 422939

## New Zealand

Busch New Zealand Ltd.  
Unit D, 41 Arrenway Drive  
Albany 0632  
Auckland  
Tel: 09 414 7782  
Fax: 09 414 7783

## Norway

Busch Vakuumteknikk AS  
Hestehagen 2  
1440 Drøbak  
Tel: 64 98 98 50  
Fax: 64 93 66 21

## Poland

Busch Polska Sp. z o.o.  
Ul. Chopina 27  
87800 Włocławek  
Tel: (054) 2315400  
Fax: (054) 2327076

## Portugal

Busch Ibérica S.A., Sucursal em Portugal  
Zona Industrial Raso de Travassô, Fracção B, Armazém 2  
3750-753 Agueda  
Aveiro, Portugal  
Tel: +351 234 648 070  
Fax: +351 234 648 068

## Singapore

Busch Vacuum Singapore Pte Ltd  
20 Shaw Road  
#01-03 Ching Shine Building  
Singapore 36 79 56  
Tel: (65) 6488 0866  
Fax: (65) 6288 0877

## Spain

Busch Ibérica S.A.  
C/ Jaume Ferran, 6-8  
Pol. Ind. Coll de la Manyà  
08403 Granollers  
Tel: +34 93 861 61 60  
Fax: +34 93 840 91 56

## Sweden

Busch Vakuumtechnik AB  
Bråta Industriområde  
435 33 Mölnlycke  
Tel: 031 - 338 00 80  
Fax: 031 - 338 00 89

## Switzerland

Busch AG  
Waldweg 22  
4312 Magden  
Tel: 061 / 845 90 90  
Fax: 061 / 845 90 99

## Taiwan

Busch Taiwan Corporation  
1F. No. 69, Sec. 3, Beishen Rd.  
Shenkeng Township,  
Taipei Country,  
Taiwan (222), R.O.C  
Tel: (02) 2662 0775  
Fax: (02) 2662 0796

## Thailand

Busch Vacuum (Thailand) Co., Ltd.  
888/30 Moo19, Soi Yingcharoen, Bangplee-Tamru Rd.,  
Bangpleeyai, Bangplee, Samutprakarn 10540 Thailand  
Tel: (66) 2-382-5428  
Fax: (66) 2-382-5429

## Turkey

VAKUTEK  
Emlak Kredi Ishani No: 179  
81130 Üsküdar-Istanbul  
Tel: (216) 310 0573  
Fax: (216) 343 5126

## United Kingdom

Busch (UK) Ltd  
Hortonwood 30-35  
Telford Shropshire TF1 7YB  
Tel: 01952 677 432  
Fax: 01952 677 423

## USA

Busch, Inc.  
516-B Viking Drive  
Virginia Beach, VA 23452  
Tel: (757) 463-7800  
Fax: (757) 463 7407

Semiconductor Vacuum Group Inc.  
Morgan Hill, CA 95037  
Tel: (408) 955 1900  
Fax: (408) 955 0229

